

## FWB2203-J

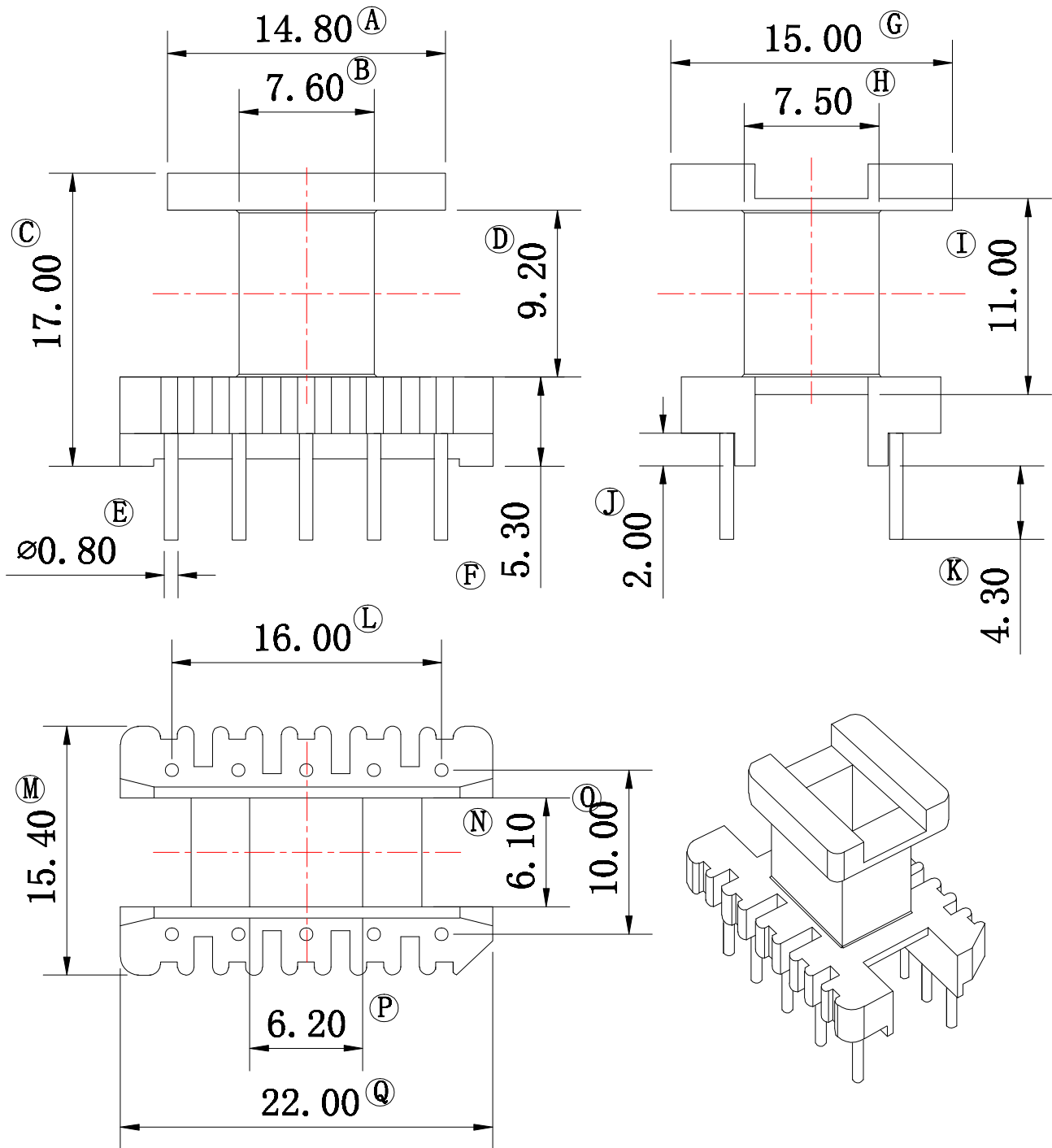

REV	REVISION RECORD	DATE	REV	REVISION RECORD	DATE
A			C		
B			D		

NAME	EE22 5+5P	MATERIAL	PHENOLIC	SCALE		ANGLE	$\pm 1^\circ$
DRAWING NO.	FWB2203-J	PIN MATERIAL	CP WIRE	UNIT	m/m	REV	A
TOLERANCE OF PIN PITCH $\pm 0.20$			<b>HAINING FERRIWO ELECTRONICS CO.,LTD.</b>				
PIN TENSION LOAD kg MN		UL REC: 94V-0	TEL: +86-573-87088701 FAX: +86-573-87081130				
TOLERANCE: 0<L≤4: ±0.2 4<L≤16: ±0.3 16<L≤63: ±0.4			Web: www.ferriwo.com Email: sales@ferriwo.com				